

# Datasheet SHT1x (SHT10, SHT11, SHT15)

## Humidity and Temperature Sensor IC

- Fully calibrated
- Digital output
- Low power consumption
- Excellent long term stability
- SMD type package – reflow solderable

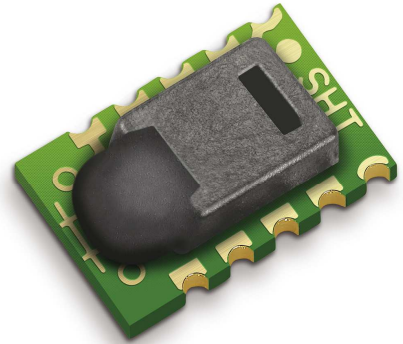

### Product Summary

SHT1x (including SHT10, SHT11 and SHT15) is Sensirion's family of surface mountable relative humidity and temperature sensors. The sensors integrate sensor elements plus signal processing on a tiny foot print and provide a fully calibrated digital output. A unique capacitive sensor element is used for measuring relative humidity while temperature is measured by a band-gap sensor. The applied CMOSens® technology guarantees excellent reliability and long term stability. Both sensors are seamlessly coupled to a 14bit analog to digital converter and a serial interface circuit. This results in superior signal quality, a fast response time and insensitivity to external disturbances (EMC).

Each SHT1x is individually calibrated in a precision humidity chamber. The calibration coefficients are programmed into an OTP memory on the chip. These coefficients are used to internally calibrate the signals from the sensors. The 2-wire serial interface and internal voltage regulation allows for easy and fast system integration. The tiny size and low power consumption makes SHT1x the ultimate choice for even the most demanding applications.

SHT1x is supplied in a surface-mountable LCC (Leadless Chip Carrier) which is approved for standard reflow soldering processes. The same sensor is also available with pins (SHT7x) or on flex print (SHTA1).

### Dimensions

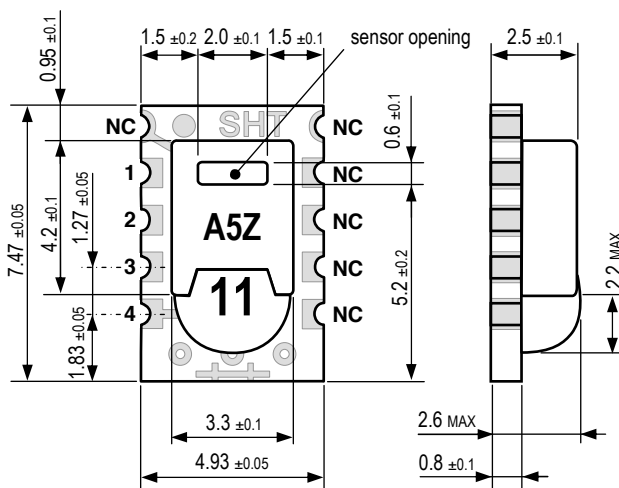

**Figure 1:** Drawing of SHT1x sensor packaging, dimensions in mm (1mm = 0.039inch). Sensor label gives “11” for SHT11 as an example. Contacts are assigned as follows: 1:GND, 2:DATA, 3:SCK, 4:VDD.

### Sensor Chip

SHT1x V4 – for which this datasheet applies – features a version 4 Silicon sensor chip. Besides the humidity and temperature sensors the chip contains an amplifier, A/D converter, OTP memory and a digital interface. V4 sensors can be identified by the alpha-numeric traceability code on the sensor cap – see example “A5Z” code on Figure 1.

### Material Contents

While the sensor is made of a CMOS chip the sensor housing consists of an LCP cap with epoxy glob top on an FR4 substrate. The device is fully RoHS and WEEE compliant, thus it is free of Pb, Cd, Hg, Cr(6+), PBB and PBDE.

### Evaluation Kits

For sensor trial measurements, for qualification of the sensor or even experimental application (data logging) of the sensor there is an evaluation kit *EK-H4* available including SHT71 (same sensor chip as SHT1x) and 4 sensor channels, hard and software to interface with a computer. For other evaluation kits please check [www.sensirion.com/humidity](http://www.sensirion.com/humidity).

## Sensor Performance

### Relative Humidity

Parameter	Condition	min	typ	max	Units
Resolution <sup>1</sup>		0.4	0.05	0.05	%RH
		8	12	12	bit
Accuracy <sup>2</sup> SHT10	typical		±4.5		%RH
	maximal	see Figure 2			
Accuracy <sup>2</sup> SHT11	typical		±3.0		%RH
	maximal	see Figure 2			
Accuracy <sup>2</sup> SHT15	typical		±2.0		%RH
	maximal	see Figure 2			
Repeatability			±0.1		%RH
Hysteresis			±1		%RH
Non-linearity	linearized		<<1		%RH
Response time <sup>3</sup>	$\tau$ (63%)		8		s
Operating Range		0		100	%RH
Long term drift <sup>4</sup>	normal		< 0.5		%RH/yr

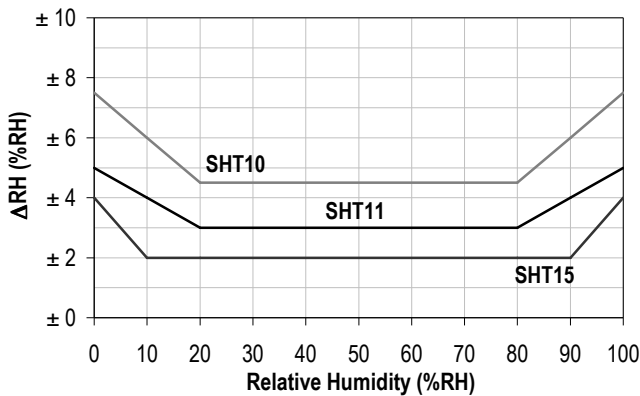

Figure 2: Maximal RH-tolerance at 25°C per sensor type.

### Electrical and General Items

Parameter	Condition	min	typ	max	Units
Source Voltage		2.4	3.3	5.5	V
Power Consumption <sup>5</sup>	sleep		2	5	μW
	measuring		3		mW
	average		90		μW
Communication	digital 2-wire interface, see Communication				
Storage	10 – 50°C (0 – 125°C peak), 20 – 60%RH				

<sup>1</sup> The default measurement resolution of is 14bit for temperature and 12bit for humidity. It can be reduced to 12/8bit by command to status register.

<sup>2</sup> Accuracies are tested at Outgoing Quality Control at 25°C (77°F) and 3.3V. Values exclude hysteresis and are applicable to non-condensing environments only.

<sup>3</sup> Time for reaching 63% of a step function, valid at 25°C and 1 m/s airflow.

### Temperature

Parameter	Condition	min	typ	max	Units
Resolution <sup>1</sup>		0.04	0.01	0.01	°C
		12	14	14	bit
Accuracy <sup>2</sup> SHT10	typical		±0.5		°C
	maximal	see Figure 3			
Accuracy <sup>2</sup> SHT11	typical		±0.4		°C
	maximal	see Figure 3			
Accuracy <sup>2</sup> SHT15	typical		±0.3		°C
	maximal	see Figure 3			
Repeatability			±0.1		°C
Operating Range		-40		123.8	°C
		-40		254.9	°F
Response Time <sup>6</sup>	$\tau$ (63%)	5		30	s
Long term drift			< 0.04		°C/yr

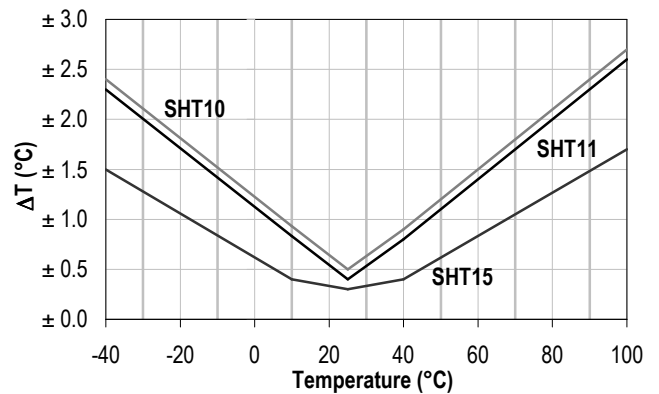

Figure 3: Maximal T-tolerance per sensor type.

### Packaging Information

Sensor Type	Packaging	Quantity	Order Number
SHT10	Tape & Reel	2000	1-100218-04
SHT11	Tape & Reel	100	1-100051-04
	Tape & Reel	400	1-100098-04
	Tape & Reel	2000	1-100524-04
SHT15	Tape & Reel	100	1-100085-04
	Tape & Reel	400	1-100093-04

This datasheet is subject to change and may be amended without prior notice.

<sup>4</sup> Value may be higher in environments with high contents of volatile organic compounds. See Section 1.3 of Users Guide.

<sup>5</sup> Values for VDD=3.3V at 25°C, average value at one 12bit measurement per second.

<sup>6</sup> Response time depends on heat capacity of and thermal resistance to sensor substrate.

# Users Guide SHT1x

## 1 Application Information

### 1.1 Operating Conditions

Sensor works stable within recommended normal range – see Figure 4. Long term exposures to conditions outside normal range, especially at humidity >80%RH, may temporarily offset the RH signal (+3 %RH after 60h). After return to normal range it will slowly return towards calibration state by itself. See Section 1.4 “Reconditioning Procedure” to accelerate eliminating the offset. Prolonged exposure to extreme conditions may accelerate ageing.

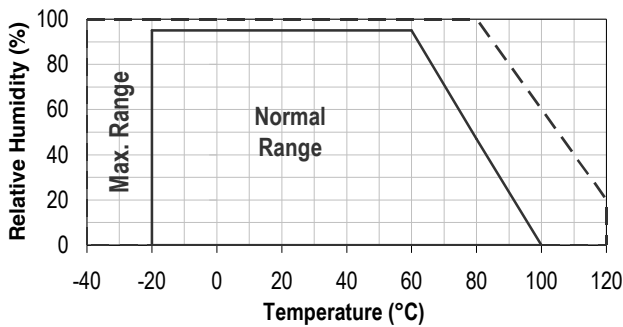

Figure 4: Operating Conditions

### 1.2 Soldering instructions

For soldering SHT1x standard reflow soldering ovens may be used. The sensor is qualified to withstand soldering profile according to IPC/JEDEC J-STD-020D with peak temperatures at 260°C during up to 40sec including Pb-free assembly in IR/Convection reflow ovens.

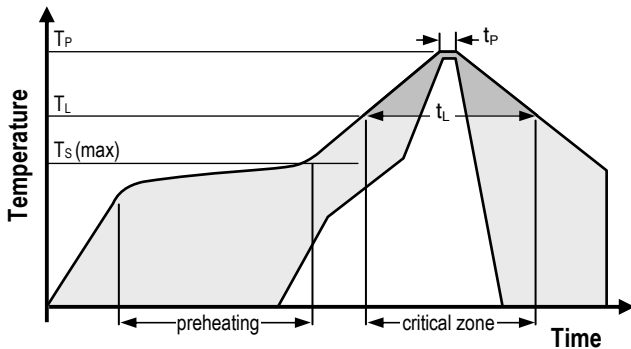

Figure 5: Soldering profile according to JEDEC standard.  $T_P \leq 260^\circ\text{C}$  and  $t_P < 40\text{sec}$  for Pb-free assembly.  $T_L < 220^\circ\text{C}$  and  $t_L < 150\text{sec}$ . Ramp-up/down speeds shall be  $< 5^\circ\text{C}/\text{sec}$ .

For soldering in Vapor Phase Reflow (VPR) ovens the peak conditions are limited to  $T_P < 233^\circ\text{C}$  during  $t_P < 60\text{sec}$  and ramp-up/down speeds shall be limited to  $10^\circ\text{C}/\text{sec}$ . For manual soldering contact time must be limited to 5 seconds at up to  $350^\circ\text{C}$ <sup>7</sup>.

<sup>7</sup>  $233^\circ\text{C} = 451^\circ\text{F}$ ,  $260^\circ\text{C} = 500^\circ\text{F}$ ,  $350^\circ\text{C} = 662^\circ\text{F}$

**IMPORTANT:** After soldering the devices should be stored at >75%RH for at least 12h to allow the polymer to re-hydrate. Otherwise the sensor may read an offset that slowly disappears if exposed to ambient conditions. Alternatively the re-hydration process may be performed at ambient conditions (>40%RH) during more than 5 days.

In no case, neither after manual nor reflow soldering, a board wash shall be applied. Therefore it is strongly recommended to use “no-clean” solder paste. In case of application with exposure of the sensor to corrosive gases or condensed water (i.e. environments with high relative humidity) the soldering pads shall be sealed (e.g. conformal coating) to prevent loose contacts or short cuts.

For the design of the SHT1x footprint it is recommended to use dimensions according to Figure 7. Sensor pads are coated with 35µm Cu, 5µm Ni and 0.1µm Au.

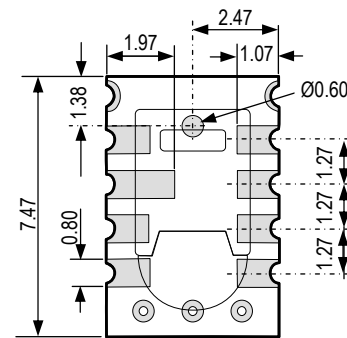

Figure 6: Rear side electrodes of sensor, view from top side.

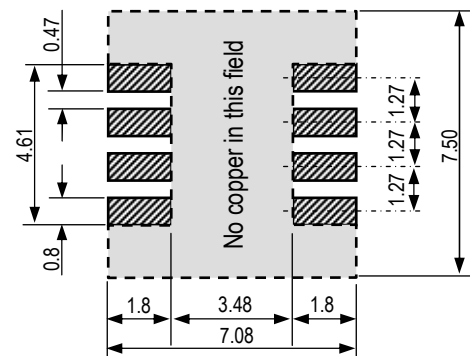

Figure 7: Recommended footprint for SHT1x. Values in mm.

### 1.3 Storage Conditions and Handling Instructions

It is of great importance to understand that a humidity sensor is not a normal electronic component and needs to be handled with care. Chemical vapors at high concentration in combination with long exposure times may offset the sensor reading.

For these reasons it is recommended to store the sensors in original packaging including the sealed ESD bag at

following conditions: Temperature shall be in the range of 10°C – 50°C (0 – 125°C for limited time) and humidity at 20 – 60%RH (sensors that are not stored in ESD bags). For sensors that have been removed from the original packaging we recommend to store them in ESD bags made of metal-in PE-HD<sup>8</sup>.

In manufacturing and transport the sensors shall be prevented of high concentration of chemical solvents and long exposure times. Out-gassing of glues, adhesive tapes and stickers or out-gassing packaging material such as bubble foils, foams, etc. shall be avoided. Manufacturing area shall be well ventilated.

For more detailed information please consult the document “*Handling Instructions*” or contact Sensirion.

**1.4 Reconditioning Procedure**

As stated above extreme conditions or exposure to solvent vapors may offset the sensor. The following reconditioning procedure may bring the sensor back to calibration state:

- Baking: 100 – 105°C at < 5%RH for 10h
- Re-Hydration: 20 – 30°C at ~ 75%RH for 12h<sup>9</sup>.

**1.5 Temperature Effects**

Relative humidity reading strongly depends on temperature. Therefore, it is essential to keep humidity sensors at the same temperature as the air of which the relative humidity is to be measured. In case of testing or qualification the reference sensor and test sensor must show equal temperature to allow for comparing humidity readings.

If the SHT1x shares a PCB with electronic components that produce heat it should be mounted in a way that prevents heat transfer or keeps it as low as possible. Measures to reduce heat transfer can be ventilation, reduction of copper layers between the SHT1x and the rest of the PCB or milling a slit into the PCB around the sensor (see Figure 8).

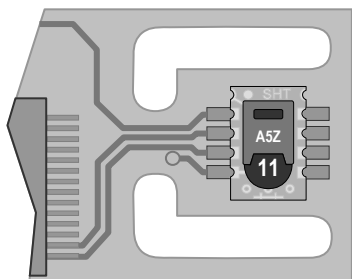

**Figure 8:** Top view of example of mounted SHT1x with slits milled into PCB to minimize heat transfer.

<sup>8</sup> For example, 3M antistatic bag, product “1910” with zipper .  
<sup>9</sup> 75%RH can conveniently be generated with saturated NaCl solution. 100 – 105°C correspond to 212 – 221°F, 20 – 30°C correspond to 68 – 86°F

Furthermore, there are self-heating effects in case the measurement frequency is too high. Please refer to Section 3.3 for detailed information.

**1.6 Light**

The SHT1x is not light sensitive. Prolonged direct exposure to sunshine or strong UV radiation may age the housing.

**1.7 Membranes**

SHT1x does not contain a membrane at the sensor opening. However, a membrane may be added to prevent dirt and droplets from entering the housing and to protect the sensor. It will also reduce peak concentrations of chemical vapors. For optimal response times the air volume behind the membrane must be kept minimal. Sensirion recommends and supplies the SF1 filter cap for optimal IP54 protection (for higher protection – i.e. IP67 - SF1 must be sealed to the PCB with epoxy). Please compare Figure 9.

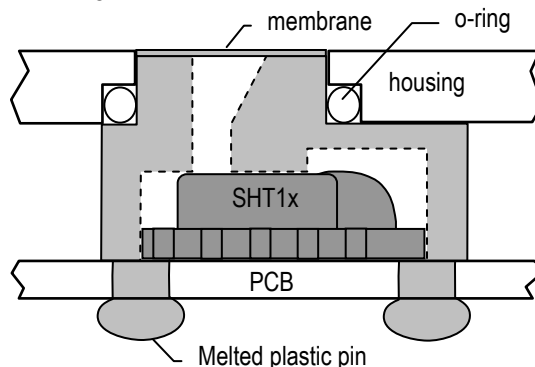

**Figure 9:** Side view of SF1 filter cap mounted between PCB and housing wall. Volume below membrane is kept minimal.

**1.8 Materials Used for Sealing / Mounting**

Many materials absorb humidity and will act as a buffer increasing response times and hysteresis. Materials in the vicinity of the sensor must therefore be carefully chosen. Recommended materials are: Any metals, LCP, POM (Delrin), PTFE (Teflon), PE, PEEK, PP, PB, PPS, PSU, PVDF, PVF.

For sealing and gluing (use sparingly): Use high filled epoxy for electronic packaging (e.g. glob top, underfill), and Silicone. Out-gassing of these materials may also contaminate the SHT1x (see Section 1.3). Therefore try to add the sensor as a last manufacturing step to the assembly, store the assembly well ventilated after manufacturing or bake at >50°C for 24h to outgas contaminants before packing.

**1.9 Wiring Considerations and Signal Integrity**

Carrying the SCK and DATA signal parallel and in close proximity (e.g. in wires) for more than 10cm may result in cross talk and loss of communication. This may be

resolved by routing VDD and/or GND between the two data signals and/or using shielded cables. Furthermore, slowing down SCK frequency will possibly improve signal integrity. Power supply pins (VDD, GND) must be decoupled with a 100nF capacitor if wires are used. Capacitor should be placed as close to the sensor as possible. Please see the Application Note “ESD, Latch-up and EMC” for more information.

### 1.10 ESD (Electrostatic Discharge)

ESD immunity is qualified according to MIL STD 883E, method 3015 (Human Body Model at ±2 kV).

Latch-up immunity is provided at a force current of ±100mA with  $T_{amb} = 80^{\circ}C$  according to JEDEC78A. See Application Note “ESD, Latch-up and EMC” for more information.

## 2 Interface Specifications

Pin	Name	Comment
1	GND	Ground
2	DATA	Serial Data, bidirectional
3	SCK	Serial Clock, input only
4	VDD	Source Voltage
NC	NC	Must be left unconnected

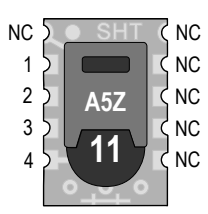

Table 1: SHT1x pin assignment, NC remain floating.

### 2.1 Power Pins (VDD, GND)

The supply voltage of SHT1x must be in the range of 2.4 – 5.5V, recommended supply voltage is 3.3V. Power supply pins Supply Voltage (VDD) and Ground (GND) must be decoupled with a 100 nF capacitor – see Figure 10.

The serial interface of the SHT1x is optimized for sensor readout and effective power consumption. The sensor cannot be addressed by I<sup>2</sup>C protocol; however, the sensor can be connected to an I<sup>2</sup>C bus without interference with other devices connected to the bus. The controller must switch between the protocols.

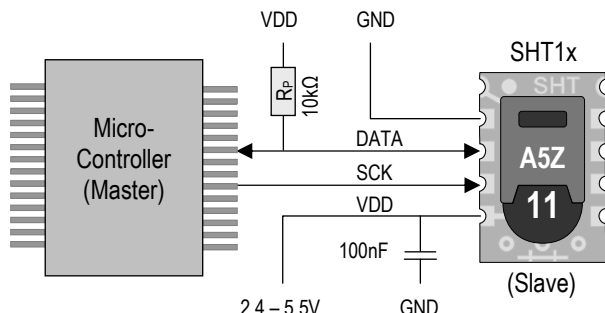

Figure 10: Typical application circuit, including pull up resistor  $R_P$  and decoupling of VDD and GND by a capacitor.

### 2.2 Serial clock input (SCK)

SCK is used to synchronize the communication between microcontroller and SHT1x. Since the interface consists of fully static logic there is no minimum SCK frequency.

### 2.3 Serial data (DATA)

The DATA tri-state pin is used to transfer data in and out of the sensor. For sending a command to the sensor, DATA is valid on the rising edge of the serial clock (SCK) and must remain stable while SCK is high. After the falling edge of SCK the DATA value may be changed. For safe communication DATA valid shall be extended  $T_{SU}$  and  $T_{HO}$  before the rising and after the falling edge of SCK, respectively – see Figure 11. For reading data from the sensor, DATA is valid  $T_V$  after SCK has gone low and remains valid until the next falling edge of SCK.

To avoid signal contention the microcontroller must only drive DATA low. An external pull-up resistor (e.g. 10kΩ) is required to pull the signal high – it should be noted that pull-up resistors may be included in I/O circuits of microcontrollers. See Table 2 for detailed I/O characteristic of the sensor.

### 2.4 Electrical Characteristics

The electrical characteristics such as power consumption, low and high level input and output voltages depend on the supply voltage. Table 2 gives electrical characteristics of SHT1x with the assumption of 5V supply voltage if not stated otherwise.

Parameter	Conditions	min	typ	max	Units
Power supply DC <sup>10</sup>		2.4	3.3	5.5	V
Supply current	measuring		0.55	1	mA
	average <sup>11</sup>	2	28		μA
	sleep		0.3	1.5	μA
Low level output voltage	$I_{OL} < 4 \text{ mA}$	0		250	mV
High level output voltage	$R_P < 25 \text{ k}\Omega$	90%		100%	VDD
Low level input voltage	Negative going	0%		20%	VDD
High level input voltage	Positive going	80%		100%	VDD
Input current on pads				1	μA
Output current	on			4	mA
	Tri-stated (off)		10	20	μA

Table 2: SHT1x DC characteristics.  $R_P$  stands for pull up resistor, while  $I_{OL}$  is low level output current.

<sup>10</sup> Recommended voltage supply for highest accuracy is 3.3V, due to sensor calibration.

<sup>11</sup> Minimum value with one measurement of 8bit resolution without OTP reload per second. Typical value with one measurement of 12bit resolution per second.

Absolute maximum ratings for VDD versus GND are +7V and -0.3V. Exposure to absolute maximum rating conditions for extended periods may affect the sensor reliability (e.g. hot carrier degradation, oxide breakdown). For proper communication with the sensor it is essential to make sure that signal design is strictly within the limits given in Table 3 and Figure 11.

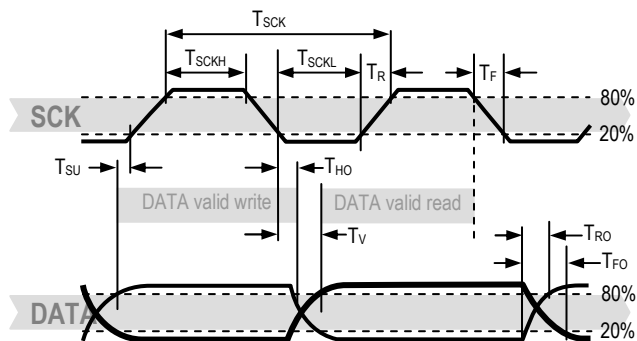

**Figure 11:** Timing Diagram, abbreviations are explained in Table 3. Bold DATA line is controlled by the sensor, plain DATA line is controlled by the micro-controller. Note that DATA valid read time is triggered by falling edge of anterior toggle.

	Parameter	Conditions	min	typ	max	Units
F <sub>SCK</sub>	SCK Frequency	VDD > 4.5V	0	0.1	5	MHz
		VDD < 4.5V	0	0.1	1	MHz
T <sub>SCKx</sub>	SCK hi/low time		100			ns
T <sub>R</sub> /T <sub>F</sub>	SCK rise/fall time		1	200	*	ns
T <sub>FO</sub>	DATA fall time	OL = 5pF	3.5	10	20	ns
		OL = 100pF	30	40	200	ns
T <sub>RO</sub>	DATA rise time		**	**	**	ns
T <sub>V</sub>	DATA valid time		200	250	***	ns
T <sub>SU</sub>	DATA setup time		100	150	***	ns
T <sub>HO</sub>	DATA hold time		10	15	****	ns

\*  $T_{R\_max} + T_{F\_max} = (F_{SCK})^{-1} - T_{SCKH} - T_{SCKL}$   
 \*\* T<sub>RO</sub> is determined by the R<sub>P</sub>\*C<sub>bus</sub> time-constant at DATA line  
 \*\*\* T<sub>V\_max</sub> and T<sub>SU\_max</sub> depend on external pull-up resistor (R<sub>P</sub>) and total bus line capacitance (C<sub>bus</sub>) at DATA line  
 \*\*\*\* T<sub>HO\_max</sub> < T<sub>V</sub> - max (T<sub>RO</sub>, T<sub>FO</sub>)

**Table 3:** SHT1x I/O signal characteristics, OL stands for Output Load, entities are displayed in Figure 11.

### 3 Communication with Sensor

#### 3.1 Start up Sensor

As a first step the sensor is powered up to chosen supply voltage VDD. The slew rate during power up shall not fall below 1V/ms. After power-up the sensor needs 11ms to get to Sleep State. No commands must be sent before that time.

#### 3.2 Sending a Command

To initiate a transmission, a Transmission Start sequence has to be issued. It consists of a lowering of the DATA line while SCK is high, followed by a low pulse on SCK and raising DATA again while SCK is still high – see Figure 12.

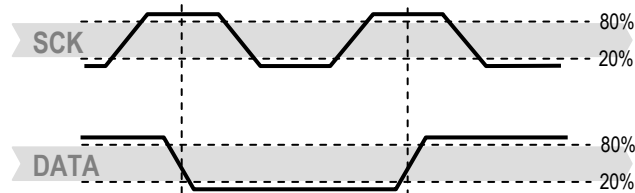

**Figure 12:** "Transmission Start" sequence

The subsequent command consists of three address bits (only '000' is supported) and five command bits. The SHT1x indicates the proper reception of a command by pulling the DATA pin low (ACK bit) after the falling edge of the 8th SCK clock. The DATA line is released (and goes high) after the falling edge of the 9th SCK clock.

Command	Code
Reserved	0000x
<b>Measure Temperature</b>	<b>00011</b>
<b>Measure Relative Humidity</b>	<b>00101</b>
Read Status Register	00111
Write Status Register	00110
Reserved	0101x-1110x
<b>Soft reset</b> , resets the interface, clears the status register to default values. Wait minimum 11 ms before next command	<b>11110</b>

**Table 4:** SHT1x list of commands

#### 3.3 Measurement of RH and T

After issuing a measurement command ('00000101' for relative humidity, '00000011' for temperature) the controller has to wait for the measurement to complete. This takes a maximum of 20/80/320 ms for a 8/12/14bit measurement. The time varies with the speed of the internal oscillator and can be lower by up to 30%. To signal the completion of a measurement, the SHT1x pulls data line low and enters Idle Mode. The controller must wait for this Data Ready signal before restarting SCK to readout the data. Measurement data is stored until readout, therefore the controller can continue with other tasks and readout at its convenience.

Two bytes of measurement data and one byte of CRC checksum (optional) will then be transmitted. The micro controller must acknowledge each byte by pulling the DATA line low. All values are MSB first, right justified (e.g. the 5<sup>th</sup> SCK is MSB for a 12bit value, for a 8bit result the first byte is not used).

Communication terminates after the acknowledge bit of the CRC data. If CRC-8 checksum is not used the controller may terminate the communication after the measurement data LSB by keeping ACK high. The device automatically returns to Sleep Mode after measurement and communication are completed.

Important: To keep self heating below 0.1°C, SHT1x should not be active for more than 10% of the time – e.g. maximum one measurement per second at 12bit accuracy shall be made.

### 3.4 Connection reset sequence

If communication with the device is lost the following signal sequence will reset the serial interface: While leaving DATA high, toggle SCK nine or more times – see Figure 13. This must be followed by a Transmission Start sequence preceding the next command. This sequence resets the interface only. The status register preserves its content.

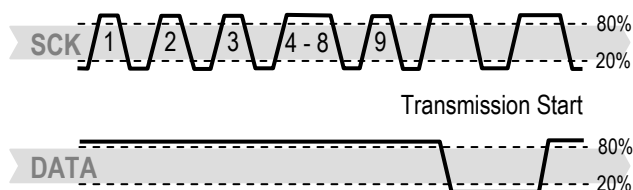

Figure 13: Connection Reset Sequence

### 3.5 CRC Checksum calculation

The whole digital transmission is secured by an 8bit checksum. It ensures that any wrong data can be detected and eliminated. As described above this is an additional feature of which may be used or abandoned. Please consult Application Note “CRC Checksum” for information on how to calculate the CRC.

### 3.6 Status Register

Some of the advanced functions of the SHT1x such as selecting measurement resolution, end-of-battery notice, use of OTP reload or using the heater may be activated by sending a command to the status register. The following section gives a brief overview of these features.

After the command Status Register Read or Status Register Write – see Table 4 – the content of 8 bits of the status register may be read out or written. For the communication compare Figure 14 and Figure 15 – the assignation of the bits is displayed in Table 5.

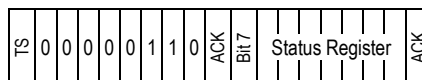

Figure 14: Status Register Write

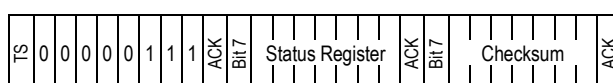

Figure 15: Status Register Read

Examples of full communication cycle are displayed in Figure 16 and Figure 17.

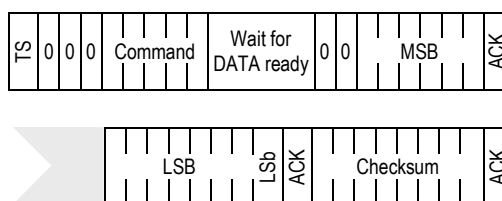

Figure 16: Overview of Measurement Sequence. TS = Transmission Start, MSB = Most Significant Bit, LSB = Last Significant Byte, LSb = Last Significant Bit.

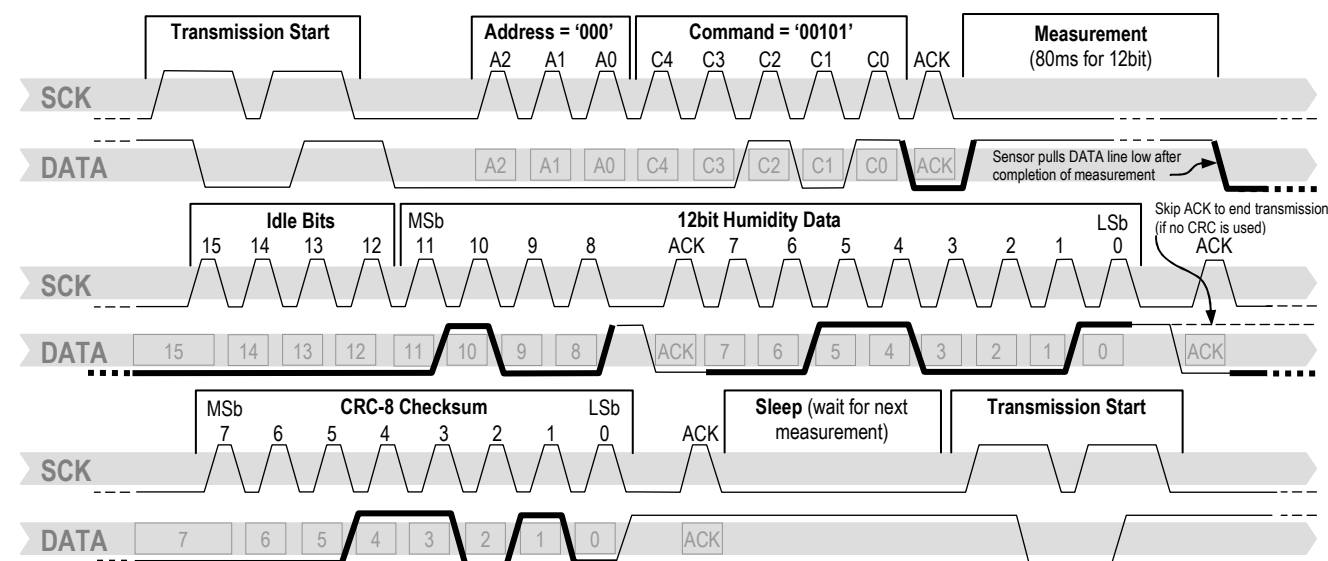

Figure 17: Example RH measurement sequence for value “0000’0100’0011’0001” = 1073 = 35.50%RH (without temperature compensation). DATA valid times are given and referenced in boxes on DATA line. Bold DATA lines are controlled by sensor while plain lines are controlled by the micro-controller.

Bit	Type	Description	Default
7		reserved	0
6	R	End of Battery (low voltage detection) '0' for VDD > 2.47 '1' for VDD < 2.47	X No default value, bit is only updated after a measurement
5		reserved	0
4		reserved	0
3		For Testing only, do not use	0
2	R/W	Heater	0 off
1	R/W	no reload from OTP	0 reload
0	R/W	'1' = 8bit RH / 12bit Temp. resolution '0' = 12bit RH / 14bit Temp. resolution	0 12bit RH 14bit Temp.

**Table 5:** Status Register Bits

**Measurement resolution:** The default measurement resolution of 14bit (temperature) and 12bit (humidity) can be reduced to 12 and 8bit. This is especially useful in high speed or extreme low power applications.

**End of Battery** function detects and notifies VDD voltages below 2.47V. Accuracy is ±0.05V.

**Heater:** An on chip heating element can be addressed by writing a command into status register. The heater may increase the temperature of the sensor by 5 – 10°C<sup>12</sup> beyond ambient temperature. The heater draws roughly 8mA @ 5V supply voltage.

For example the heater can be helpful for functionality analysis: Humidity and temperature readings before and after applying the heater are compared. Temperature shall increase while relative humidity decreases at the same time. Dew point shall remain the same.

Please note: The temperature reading will display the temperature of the heated sensor element and not ambient temperature. Furthermore, the sensor is not qualified for continuous application of the heater.

**OTP reload:** With this operation the calibration data is uploaded to the register before each measurement. This may be deactivated for reducing measurement time by about 10ms.

## 4 Conversion of Signal Output

### 4.1 Relative Humidity

For compensating non-linearity of the humidity sensor – see Figure 18 – and for obtaining the full accuracy of the sensor it is recommended to convert the humidity readout

(SO<sub>RH</sub>) with the following formula with coefficients given in Table 6:

$$RH_{linear} = c_1 + c_2 \cdot SO_{RH} + c_3 \cdot SO_{RH}^2 \text{ (%RH)}$$

SO <sub>RH</sub>	c <sub>1</sub>	c <sub>2</sub>	c <sub>3</sub>
12 bit	-2.0468	0.0367	-1.5955E-6
8 bit	-2.0468	0.5872	-4.0845E-4

**Table 6:** Humidity conversion coefficients

Values higher than 99% RH indicate fully saturated air and must be processed and displayed as 100%RH<sup>13</sup>. Please note that the humidity sensor has no significant voltage dependency.

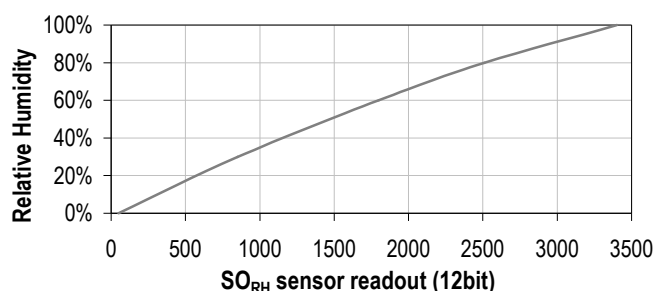

**Figure 18:** Conversion from SO<sub>RH</sub> to relative humidity

### 4.2 Temperature compensation of Humidity Signal

For temperatures significantly different from 25°C (~77°F) the humidity signal requires temperature compensation. The temperature correction corresponds roughly to 0.12%RH/°C @ 50%RH. Coefficients for the temperature compensation are given in Table 7.

$$RH_{true} = (T_{°C} - 25) \cdot (t_1 + t_2 \cdot SO_{RH}) + RH_{linear}$$

SO <sub>RH</sub>	t <sub>1</sub>	t <sub>2</sub>
12 bit	0.01	0.00008
8 bit	0.01	0.00128

**Table 7:** Temperature compensation coefficients

### 4.3 Temperature

The band-gap PTAT (Proportional To Absolute Temperature) temperature sensor is very linear by design. Use the following formula to convert digital readout (SO<sub>T</sub>) to temperature value, with coefficients given in Table 8:

$$T = d_1 + d_2 \cdot SO_T$$

<sup>13</sup> If wetted excessively (strong condensation of water on sensor surface), sensor output signal can drop below 100%RH (even below 0%RH in some cases), but the sensor will recover completely when water droplets evaporate. The sensor is not damaged by water immersion or condensation.

<sup>12</sup> Corresponds to 9 – 18°F



VDD	d <sub>1</sub> (°C)	d <sub>1</sub> (°F)	SO <sub>T</sub>	d <sub>2</sub> (°C)	d <sub>2</sub> (°F)
5V	-40.1	-40.2	14bit	0.01	0.018
4V	-39.8	-39.6	12bit	0.04	0.072
3.5V	-39.7	-39.5			
3V	-39.6	-39.3			
2.5V	-39.4	-38.9			

**Table 8:** Temperature conversion coefficients.

#### 4.4 Dew Point

SHT1x is not measuring dew point directly, however dew point can be derived from humidity and temperature readings. Since humidity and temperature are both measured on the same monolithic chip, the SHT1x allows superb dew point measurements.

For dew point (T<sub>d</sub>) calculations there are various formulas to be applied, most of them quite complicated. For the temperature range of -40 – 50°C the following approximation provides good accuracy with parameters given in Table 9:

$$T_d(RH, T) = T_n \cdot \frac{\ln\left(\frac{RH}{100\%}\right) + \frac{m \cdot T}{T_n + T}}{m - \ln\left(\frac{RH}{100\%}\right) - \frac{m \cdot T}{T_n + T}}$$

Temperature Range	T <sub>n</sub> (°C)	m
Above water, 0 – 50°C	243.12	17.62
Above ice, -40 – 0°C	272.62	22.46

**Table 9:** Parameters for dew point (T<sub>d</sub>) calculation.

Please note that “ln(...)” denotes the natural logarithm. For RH and T the linearized and compensated values for relative humidity and temperature shall be applied.

For more information on dew point calculation see Application Note “Introduction to Humidity”.

## 5 Environmental Stability

If sensors are qualified for assemblies or devices, please make sure that they experience same conditions as the reference sensor. It should be taken into account that response times in assemblies may be longer, hence enough dwell time for the measurement shall be granted. For detailed information please consult Application Note “Qualification Guide”.

The SHT1x sensor series were tested according to AEC-Q100 Rev. G qualification test method. Sensor specifications are tested to prevail under the AEC-Q100

temperature grade 2 test conditions listed in Table 10<sup>14</sup>. Sensor performance under other test conditions cannot be guaranteed and is not part of the sensor specifications. Especially, no guarantee can be given for sensor performance in the field or for customer’s specific application.

Please contact Sensirion for detailed information.

Environment	Standard	Results <sup>15</sup>
HTSL	125°C, 1000 hours	Within specifications
TC	-50°C - 125°C, 1000 cycles Acc. JESD22-A104-C	Within specifications
UHST	130°C / 85%RH / ≈2.3bar, 96h	Within specifications
THU	85°C / 85%RH, 1000h	Within specifications
ESD immunity	MIL STD 883E, method 3015 (Human Body Model at ±2kV)	Qualified
Latch-up	force current of ±100mA with T <sub>amb</sub> = 80°C, acc. JEDEC 17	Qualified

**Table 10:** Qualification tests: HTSL = High Temperature Storage Lifetime, TC = Temperature Cycles, UHST = Unbiased Highly accelerated Stress Test, THB = Temperature Humidity Unbiased

## 6 Packaging

### 6.1 Packaging type

SHT1x are supplied in a surface mountable LCC (Leadless Chip Carrier) type package. The sensor housing consists of a Liquid Crystal Polymer (LCP) cap with epoxy glob top on a standard 0.8mm FR4 substrate. The device is fully RoHS and WEEE compliant – it is free of Pb, Cd, Hg, Cr(6+), PBB and PBDE.

Device size is 7.47 x 4.93 x 2.5 mm (0.29 x 0.19 x 0.1 inch), see Figure 1, weight is 100 mg.

### 6.2 Traceability Information

All SHT1x are marked with an alphanumeric, three digit code on the chip cap – see “A5Z” on Figure 1. The lot numbers allow full traceability through production, calibration and testing. No information can be derived from the code directly; respective data is stored at Sensirion and is provided upon request.

Labels on the reels are displayed in Figures 19 and 20, they both give traceability information.

<sup>14</sup> Sensor operation temperature range is -40 to 105°C according to AEC-Q100 temperature grade 2.

<sup>15</sup> According to accuracy and long term drift specification given on Page 2.



**Figure 19:** First label on reel: XX = Sensor Type (11 for SHT11), NN = Chip Version (04 for V4), Y = last digit of year, RRR = number of sensors on reel divided by 10 (200 for 2000 units), TTTTT = Traceability Code.

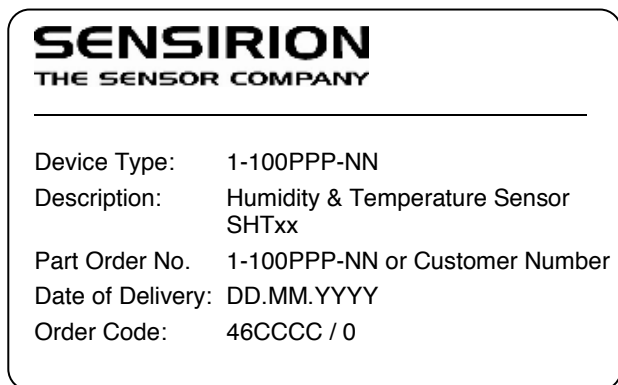

**Figure 20:** Second label on reel: For Device Type and Part Order Number please refer to Table 12, Delivery Date (also Date Code) is date of packaging of sensors (DD = day, MM = month, YYYY = year), CCCC = Sensirion order number.

**6.3 Shipping Package**

SHT1x are shipped in 12mm tape at 100pcs, 400pcs and 2000pcs – for details see Figure 21 and Table 11. Reels

are individually labeled with barcode and human readable labels.

Sensor Type	Packaging	Quantity	Order Number
SHT10	Tape & Reel	2000	1-100218-04
SHT11	Tape & Reel	100	1-100051-04
	Tape & Reel	400	1-100098-04
	Tape & Reel	2000	1-100524-04
SHT15	Tape & Reel	100	1-100085-04
	Tape & Reel	400	1-100093-04

**Table 11:** Packaging types per sensor type.

Dimensions of packaging tape are given in Figure 21. All tapes have a minimum of 480mm empty leader tape (first pockets of the tape) and a minimum of 300mm empty trailer tape (last pockets of the tape).

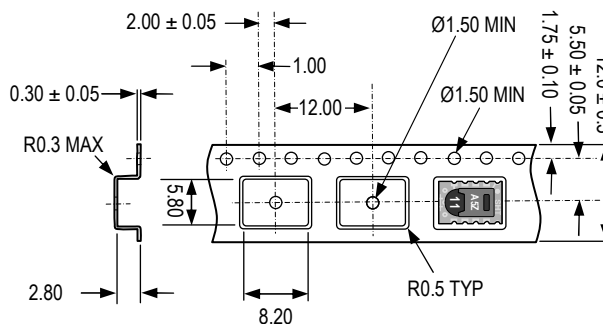

**Figure 21:** Tape configuration and unit orientation within tape, dimensions in mm (1mm = 0.039inch). The leader tape is at the right side of the figure while the trailer tape is to the left (direction of unreeling).

## Revision History

Date	Version	Page(s)	Changes
July 2008	4.0	1 – 11	New release, rework of datasheet
September 2008	4.1	3, 4	Adjustment of normal operating range and recommendation for antistatic bag
April 2009	4.2	2, 7	Amended foot note 2, communication diagram updated (Figure 17).
May 2010	4.3	1 – 11	Various errors corrected and additional information given (ask for change protocol).
December 2011	5	1, 8, 9	Reference to V3 sensors eliminated.

## Important Notices

### Warning, Personal Injury

**Do not use this product as safety or emergency stop devices or in any other application where failure of the product could result in personal injury. Do not use this product for applications other than its intended and authorized use. Before installing, handling, using or servicing this product, please consult the data sheet and application notes. Failure to comply with these instructions could result in death or serious injury.**

If the Buyer shall purchase or use SENSIRION products for any unintended or unauthorized application, Buyer shall defend, indemnify and hold harmless SENSIRION and its officers, employees, subsidiaries, affiliates and distributors against all claims, costs, damages and expenses, and reasonable attorney fees arising out of, directly or indirectly, any claim of personal injury or death associated with such unintended or unauthorized use, even if SENSIRION shall be allegedly negligent with respect to the design or the manufacture of the product.

### ESD Precautions

The inherent design of this component causes it to be sensitive to electrostatic discharge (ESD). To prevent ESD-induced damage and/or degradation, take customary and statutory ESD precautions when handling this product.

See application note "ESD, Latchup and EMC" for more information.

### Warranty

SENSIRION warrants solely to the original purchaser of this product for a period of 12 months (one year) from the date of delivery that this product shall be of the quality, material and workmanship defined in SENSIRION's published specifications of the product. Within such period, if proven to be defective, SENSIRION shall repair and/or replace this product, in SENSIRION's discretion, free of charge to the Buyer, provided that:

- notice in writing describing the defects shall be given to SENSIRION within fourteen (14) days after their appearance;

- such defects shall be found, to SENSIRION's reasonable satisfaction, to have arisen from SENSIRION's faulty design, material, or workmanship;
- the defective product shall be returned to SENSIRION's factory at the Buyer's expense; and
- the warranty period for any repaired or replaced product shall be limited to the unexpired portion of the original period.

This warranty does not apply to any equipment which has not been installed and used within the specifications recommended by SENSIRION for the intended and proper use of the equipment. EXCEPT FOR THE WARRANTIES EXPRESSLY SET FORTH HEREIN, SENSIRION MAKES NO WARRANTIES, EITHER EXPRESS OR IMPLIED, WITH RESPECT TO THE PRODUCT. ANY AND ALL WARRANTIES, INCLUDING WITHOUT LIMITATION, WARRANTIES OF MERCHANTABILITY OR FITNESS FOR A PARTICULAR PURPOSE, ARE EXPRESSLY EXCLUDED AND DECLINED.

SENSIRION is only liable for defects of this product arising under the conditions of operation provided for in the data sheet and proper use of the goods. SENSIRION explicitly disclaims all warranties, express or implied, for any period during which the goods are operated or stored not in accordance with the technical specifications.

SENSIRION does not assume any liability arising out of any application or use of any product or circuit and specifically disclaims any and all liability, including without limitation consequential or incidental damages. All operating parameters, including without limitation recommended parameters, must be validated for each customer's applications by customer's technical experts. Recommended parameters can and do vary in different applications.

SENSIRION reserves the right, without further notice, (i) to change the product specifications and/or the information in this document and (ii) to improve reliability, functions and design of this product.

Copyright© 2011, SENSIRION.  
CMOSens® is a trademark of Sensirion  
All rights reserved

## Headquarters and Subsidiaries

SENSIRION AG  
Laubisruetistr. 50  
CH-8712 Staefa 19  
Switzerland

phone: +41 44 306 40 00  
fax: +41 44 306 40 30  
[info@sensirion.com](mailto:info@sensirion.com)  
[www.sensirion.com](http://www.sensirion.com)

Sensirion AG (Germany)  
phone: +41 44 927 11 66  
[info@sensirion.com](mailto:info@sensirion.com)  
[www.sensirion.com](http://www.sensirion.com)

Sensirion Inc., USA  
phone: +1 805 409 4900  
[info\\_us@sensirion.com](mailto:info_us@sensirion.com)  
[www.sensirion.com](http://www.sensirion.com)

Sensirion Japan Co. Ltd.  
phone: +81 3 3444 4940  
[info@sensirion.co.jp](mailto:info@sensirion.co.jp)  
[www.sensirion.co.jp](http://www.sensirion.co.jp)

Sensirion Korea Co. Ltd.  
phone: +82 31 345 0031 3  
[info@sensirion.co.kr](mailto:info@sensirion.co.kr)  
[www.sensirion.co.kr](http://www.sensirion.co.kr)

Sensirion China Co. Ltd.  
phone: +86 755 8252 1501  
[info@sensirion.com.cn](mailto:info@sensirion.com.cn)  
[www.sensirion.com.cn](http://www.sensirion.com.cn)

To find your local representative, please visit [www.sensirion.com/contact](http://www.sensirion.com/contact)