

Specification

Part No.:YK5014WC-DB

Main descriptions:

- Device Outline: 5mm Round
- Viewing angle:15°
- Single color: White
- Water clear epoxy lens
- High intensity, reliability and long life
- Environmental friendly, RoHs compliant

Add: No. 188 Beihai Road, Jiangbei District, Ningbo, Zhejiang, China

Tel:+86-574-83092210, 83092212 Fax:+86-574-83092213

[Http://www.yongking.com](http://www.yongking.com)

E-mail: sales@yongking.com

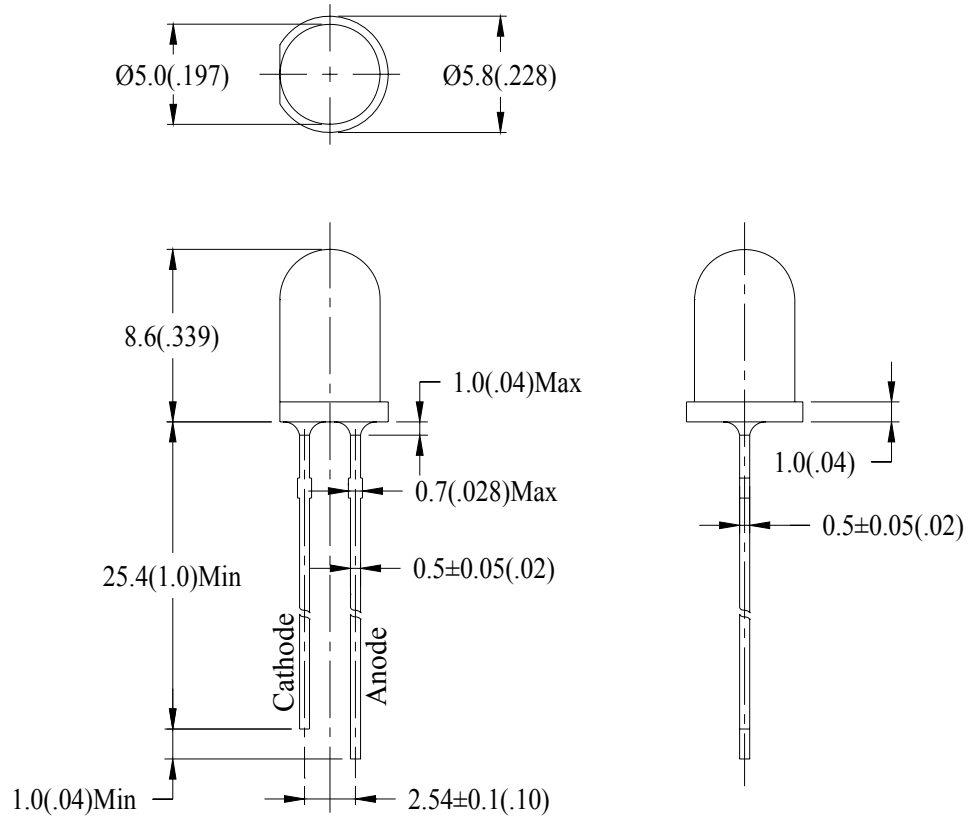

| Part No | Dice material | Lens color | Emitting Color |
|-------------|---------------|-------------|----------------|
| YK5014WC-DB | InGaN | Water Clear | White |

Note:

1. All dimensions are in millilitre (inches).
2. Tolerance is ± 0.25 mm (.010") unless other noted.
3. Specifications are subject to change without notice.
4. Bare iron is exposed at tie-bar portion after cutting. The lamps have sharp and hard points that may injure human eyes or fingers etc., so please pay enough care in the handing.

● Absolute maximum ratings (Ta = 25°C)

| Parameter | Symbol | Test Condition | Values | | Unit |
|-----------------------|--------|------------------|--------|-----|------|
| | | | Min | Max | |
| Reverse Voltage | VR | IR=10uA | -- | 7 | V |
| Forward Current | IF | --- | -- | 20 | mA |
| Power Dissipation | Pd | --- | -- | 70 | mW |
| Pulse Current | Ipeak | Duty=0.1mS, 1kHz | -- | 100 | mA |
| Operating Temperature | Topr | --- | -30 | 80 | °C |
| Storage Temperature | Tstr | --- | -30 | 80 | °C |

● Electrical and optical characteristics (Ta = 25°C)

| Parameter | Symbol | Test Condition | Values | | | Unit |
|---------------------|---------|----------------|--------|-------|-------|------|
| | | | Min | Avg | Max | |
| Forward Voltage | VF | IF=20mA | 3.0 | 3.2 | 3.5 | V |
| Reverse Current | IR | VR=7V | | | 5 | uA |
| Dominate Wavelength | TC | IF=20mA | 6000 | 7000 | 8000 | K |
| Luminous Intensity | IV | IF=20mA | 20000 | 22000 | 25000 | mcd |
| Viewing Angle | 2 θ 1/2 | IF=20mA | | 15 | | Deg |

Reliability

1. Test Items and Results

| Test Item | Standard Test Method | Test Conditions | Note | Number of Damaged |
|---|--------------------------|--|-------------------------|-------------------|
| Resistance to Soldering Heat | JEITA ED-4701 300 302 | Tsld=260±5°C, 10sec 1.6mm from the base of the epoxy bulb | 1 time | 0/100 |
| Solderability | JEITA ED-4701 300 303 | Tsld=235±5°C, 5sec(using flux) | 1time over 95% | 0/100 |
| Thermal Shock | JEITA ED-4701 300 307 | 0°C↔100°C 15sec, 15sec | 100 cycles | 0/100 |
| Temperature Cycle | JEITA ED-4701 100 105 | -40°C~25°C~100°C~25°C 30min, 5min, 30min, 5min | 100 cycles | 0/100 |
| Moisture Resistance Cynic | JEITA ED-4701 200 203 | 25°C~65°C~-10°C 90%RH 24hrs/1cycle | 10 cycles | 0/100 |
| High Temperature Storage | JEITA ED-4701 200 201 | Ta=100°C | 1000hrs | 0/100 |
| Terminal Strength (Pull test) | JEITA ED-4701 400 401 | add 10N (1kgf) 10±1sec | No noticeable damage | 0/100 |
| Terminal Strength (bending test) | JEITA ED-4701 400 401 | Load 5N (0.5kgf) 0°~90°~0° bend 2 times | No noticeable damage | 0/100 |
| Temperature Humidity Storage | JEITA ED-4701 100 103 | Ta=60°C, RH=90% | 1000hrs | 0/100 |
| Low Temperature Storage | JEITA ED-4701 200 202 | Ta=-40°C | 1000hrs | 0/100 |
| Steady State Operating Life | — | Ta=25°C, If=20mA | 1000hrs | 0/100 |
| Steady State Operating Life of High Humidity Heat | — | Ta=60°C, RH=90%, If=20mA | 500hrs | 0/100 |
| Steady State Operating Life of Low Temperature | — | Ta=-30°C, If=20mA | 1000hrs | 0/100 |

2. Criteria For Judging The Damage

| Item | Symbol | Test Conditions | Criteria for Judgement | |
|--------------------|----------------|----------------------|------------------------|------------|
| | | | Min | Max |
| Forward Voltage | V _F | I _F =20mA | — | F.V.*)×1.1 |
| Reverse Current | I _R | V _R =5V | — | F.V.*)×2.0 |
| Luminous Intensity | I _v | I _F =20mA | F.V.*)×0.7 | — |

■ Spectrum Distribution

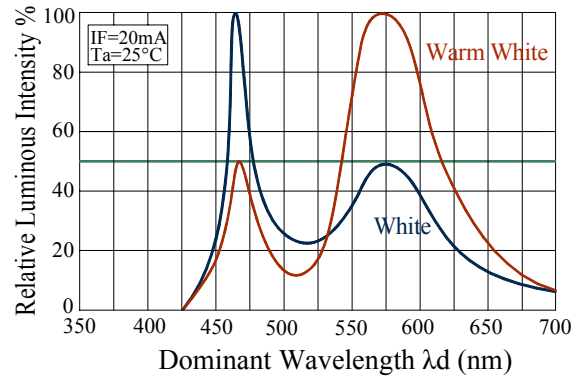
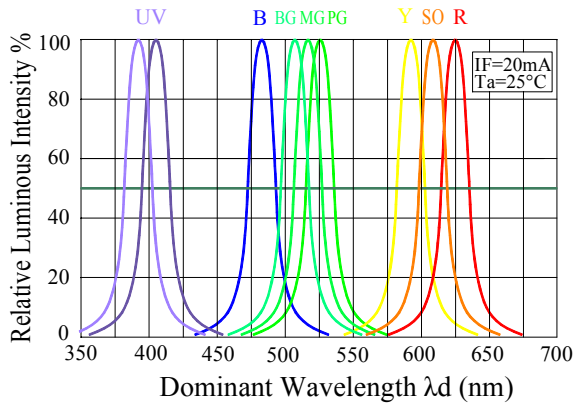

■ Forward Voltage Vs Forward Current

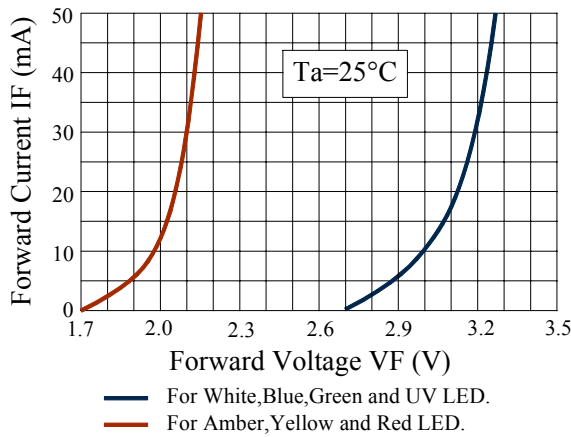

■ Forward Current Vs Relative Luminous Intensity

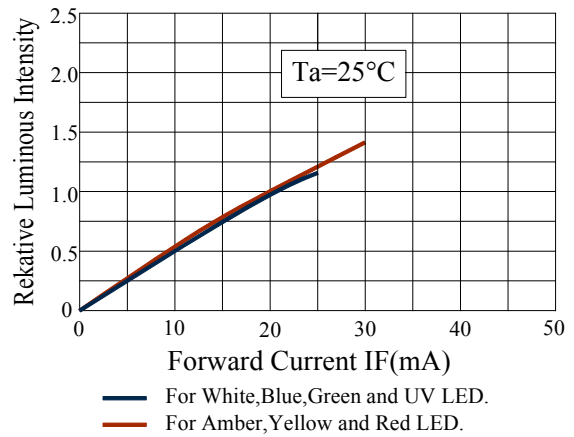

■ Ambient Temperature Vs Forward Current

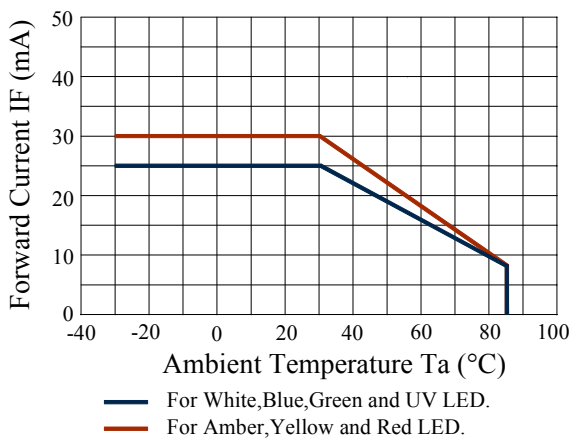

■ Directivity

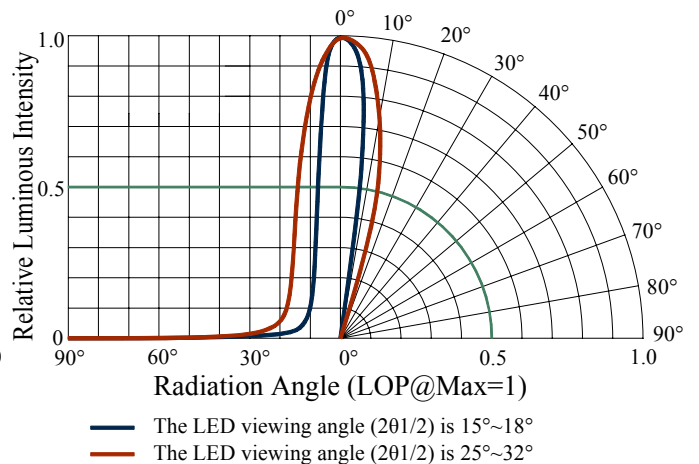

➤ **Cautions:**

1. Lead Forming

- 1.1) Any forming on the lead must be done before soldering, not during or after soldering.
- 1.2) Avoid applying any stress to resin for preventing the epoxy fracture and break up bonding wire.
- 1.3) While forming, please use a tie bar cut or equivalent to hold or bend the pin.
- 1.4) 2mm from the base or resin is the minimum of distance for the bending point at the lead pin.
- 1.5) Avoid bending the lead pin at the same point twice or more.

2. Cleaning

- 2.1) It is recommended that isopropyl alcohol be used as a solvent for cleaning the LED. When using other solvents, it should be confirmed beforehand whether the solvents would dissolve the resin or not.
- 2.2) Do not clean the LED with the ultrasonic. When it is absolutely necessary, the influence of ultrasonic cleaning on the LED depends on factors such as ultrasonic power and the assembled condition. Before cleaning, a pretest should be done to confirm whether any damages to the LED would occur.

3. Soldering

- 3.1) Pin hole pitch on PCB must match lead pin pitch so as not to cause any stress on lead wires.
- 3.2) No heat should be applied to lead pins when they are soldered, otherwise disconnection may occur.
- 3.3) Three minutes are necessary for LED to cool down to normal room temperature.

4. Static Electricity

- 4.1) Static electricity or surge voltage damages the LED. It is recommended that a wrist band or an anti-electrostatic glove be used when handling the LED.
- 4.2) All devices, equipment and machinery must be properly grounded. It is recommended that measures be taken against surge voltage to the equipment that mounts the LED.
- 4.3) When inspecting the final products in which LED were assembled, it is recommended to check whether the assembled LED are damaged by static electricity or not. It is easy to find static-damaged LED by a light-on test or a V_F test at a lower current (below 1 mA is recommended).
- 4.4) Damaged LED will show some unusual characteristics such as the leak current remarkably increases, the forward voltage becomes lower, or the LED do not light at the low current.

5. Heat Generation

- 5.1) Thermal design of the end product is very importance. Please consider the heat generation of the LED when making the system design. The coefficient of temperature increase per input electric power is affected by the thermal resistance of the PCB board and the placement of the LED, as well as other components. It is necessary to

THE END